

AWM-SERWIS GUZOWSKI

**KATALOG CZĘŚCI ZAMIENNYCH
BYSTRONIC®**

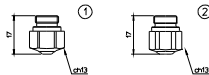



POZ.	NR AWM	NR BYSTRONIC	OPIS	
1	H674	3-04277 HK08	BYSTRONIC NOZZLE - 0.8 mm HD	
	H72	3-01910 HK10	BYSTRONIC NOZZLE - 1.0 mm HD	
	H121	3-01911 HK12	BYSTRONIC NOZZLE - 1.25 mm HD	
	H73	3-01912 HK15	BYSTRONIC NOZZLE - 1.5 mm HD	
	H122	3-01913 HK17	BYSTRONIC NOZZLE - 1.75 mm HD	
	H72X	3-01910 HK10	BYSTRONIC NOZZLE - 1.0 mm HD CP	
	H121X	3-01911 HK12	BYSTRONIC NOZZLE - 1.25 mm HD CP	
	H73X	3-01912 HK15	BYSTRONIC NOZZLE - 1.5 mm HD CP	
	H122X	3-01913 HK17	BYSTRONIC NOZZLE - 1.75 mm HD CP	
	2	H123	3-01914 HK20	BYSTRONIC NOZZLE - 2.0 mm HD
		H140	3-03854 HK25	BYSTRONIC NOZZLE - 2.5 mm HD
		H265	3-06112 HK30	BYSTRONIC NOZZLE - 3.0 mm HD
		H700	HK35	BYSTRONIC NOZZLE - 3.5 mm HD
H701		HK40	BYSTRONIC NOZZLE - 4.0 mm HD	
H123X		3-01914 HK20	BYSTRONIC NOZZLE - 2.0 mm HD CP	
H140X		3-03854 HK25	BYSTRONIC NOZZLE - 2.5 mm HD CP	
H265X		3-06112 HK30	BYSTRONIC NOZZLE - 3.0 mm HD CP	
H700X		HK35	BYSTRONIC NOZZLE - 3.5 mm HD CP	
H701X		HK40	BYSTRONIC NOZZLE - 4.0 mm HD CP	

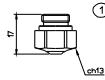

POZ.	NR AWM	NR BYSTRONIC	OPIS
1	H83	3-04273 K08	BYSTRONIC NOZZLE - 0.8 mm
	H116	3-01905 K10	BYSTRONIC NOZZLE - 1.0 mm
	H117	3-01906 K12	BYSTRONIC NOZZLE - 1.25 mm
	H118	3-01907 K15	BYSTRONIC NOZZLE - 1.5 mm
	H119	3-01908 K17	BYSTRONIC NOZZLE - 1.75 mm
	H120	3-01909 K20	BYSTRONIC NOZZLE - 2.0 mm
	H675	3-04274 K25	BYSTRONIC NOZZLE - 2.5 mm
	H678	3-04275 K30	BYSTRONIC NOZZLE - 3.0 mm
	H83X	3-04273 K08	BYSTRONIC NOZZLE - 0.8 mm CP
	H116X	3-01905 K10	BYSTRONIC NOZZLE - 1.0 mm CP
	H117X	3-01906 K12	BYSTRONIC NOZZLE - 1.25 mm CP
	H118X	3-01907 K15	BYSTRONIC NOZZLE - 1.5 mm CP
	H119X	3-01908 K17	BYSTRONIC NOZZLE - 1.75 mm CP
	H120X	3-01909 K20	BYSTRONIC NOZZLE - 2.0 mm CP
	H675X	3-04274 K25	BYSTRONIC NOZZLE - 2.5 mm CP
	H678X	3-04275 K30	BYSTRONIC NOZZLE - 3.0 mm CP

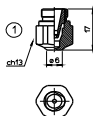

POZ.	NR KAT.	NR PROD.	OPIS
1	H1363	3-16058 NK10 - 15	BYSTRONIC DOUBLE NOZZLE - 1.0 mm
	H1364	3-16059 NK12 - 15	BYSTRONIC DOUBLE NOZZLE - 1.25 mm
	H1365	3-16060 NK15 - 15	BYSTRONIC DOUBLE NOZZLE - 1.5 mm
	H1366	3-14317 NK17 - 15	BYSTRONIC DOUBLE NOZZLE - 1.75 mm
	H604	3-14318 NK20 - 15	BYSTRONIC DOUBLE NOZZLE - 2.0 mm
	H605	3-14319 NK25 - 15	BYSTRONIC DOUBLE NOZZLE - 2.5 mm
	H612	3-16256 NK25 - 20	BYSTRONIC DOUBLE NOZZLE - 2.5 mm
	H613	3-16061 NK30 - 17	BYSTRONIC DOUBLE NOZZLE - 3.0 mm
	H606	3-16257 NK30 - 20	BYSTRONIC DOUBLE NOZZLE - 3.0 mm
	H607	NK35-30	BYSTRONIC DOUBLE NOZZLE - 3.5 mm
	H1363X	3-16058 NK10 - 15	BYSTRONIC DOUBLE NOZZLE - 1.0 mm CP
	H1364X	3-16059 NK12 - 15	BYSTRONIC DOUBLE NOZZLE - 1.25 mm CP
	H1365X	3-16060 NK15 - 15	BYSTRONIC DOUBLE NOZZLE - 1.5 mm CP
	H1366X	3-14317 NK17 - 15	BYSTRONIC DOUBLE NOZZLE - 1.75 mm CP
	H604X	3-14318 NK20 - 15	BYSTRONIC DOUBLE NOZZLE - 2.0 mm CP
	H605X	3-14319 NK25 - 15	BYSTRONIC DOUBLE NOZZLE - 2.5 mm CP
	H612X	3-16256 NK25 - 20	BYSTRONIC DOUBLE NOZZLE - 2.5 mm CP
	H613X	3-16061 NK30 - 17	BYSTRONIC DOUBLE NOZZLE - 3.0 mm CP
	H606X	3-16257 NK30 - 20	BYSTRONIC DOUBLE NOZZLE - 3.0 mm CP
	H607X	NK35-30	BYSTRONIC DOUBLE NOZZLE - 3.5 mm CP

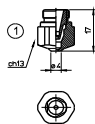

POZ.	NR KAT.	NR PROD.	OPIS
1	H600	3-16058 NK10 - 15	BYSTRONIC DOUBLE NOZZLE - 1.0 mm
	H601	3-16059 NK12 - 15	BYSTRONIC DOUBLE NOZZLE - 1.25 mm
	H602	3-16060 NK15 - 15	BYSTRONIC DOUBLE NOZZLE - 1.5 mm
	H603	3-14317 NK17 - 15	BYSTRONIC DOUBLE NOZZLE - 1.75 mm
	H600X	3-16058 NK10 - 15	BYSTRONIC DOUBLE NOZZLE - 1.0 mm CP
	H601X	3-16059 NK12 - 15	BYSTRONIC DOUBLE NOZZLE - 1.25 mm CP
	H602X	3-16060 NK15 - 15	BYSTRONIC DOUBLE NOZZLE - 1.5 mm CP
	H603X	3-14317 NK17 - 15	BYSTRONIC DOUBLE NOZZLE - 1.75 mm CP



POZ.	NR AWM	NR BYSTRONIC	OPIS
1	H82	3-04271 08	BYSTRONIC NOZZLE - 0.8 mm
	H98	3-01894 10	BYSTRONIC NOZZLE - 1.0 mm
	H99	3-01895 12	BYSTRONIC NOZZLE - 1.25 mm
	H100	3-01896 15	BYSTRONIC NOZZLE - 1.5 mm
	H101	3-01897 17	BYSTRONIC NOZZLE - 1.75 mm
	H102	3-01898 20	BYSTRONIC NOZZLE - 2.0 mm
	H676	3-04272 25	BYSTRONIC NOZZLE - 2.5 mm
	H673	3-04275 H08	BYSTRONIC NOZZLE - 0.8 mm HD
	H88	3-01899 H10	BYSTRONIC NOZZLE - 1.0 mm HD
	H103	3-01900 H12	BYSTRONIC NOZZLE - 1.25 mm HD
	H104	3-01901 H15	BYSTRONIC NOZZLE - 1.5 mm HD
	H105	3-01902 H17	BYSTRONIC NOZZLE - 1.75 mm HD
	H106	3-01903 H20	BYSTRONIC NOZZLE - 2.0 mm HD
	H677	3-04276 H25	BYSTRONIC NOZZLE - 2.5 mm HD
	H679	H30	BYSTRONIC NOZZLE - 3.0 mm HD
	H88X	3-01899 H10	BYSTRONIC NOZZLE - 1.0 mm HD CP
	H103X	3-01900 H12	BYSTRONIC NOZZLE - 1.25 mm HD CP
	H104X	3-01901 H15	BYSTRONIC NOZZLE - 1.5 mm HD CP
	H105X	3-01902 H17	BYSTRONIC NOZZLE - 1.75 mm HD CP
	H106X	3-01903 H20	BYSTRONIC NOZZLE - 2.0 mm HD CP
	H677X	3-04276 H25	BYSTRONIC NOZZLE - 2.5 mm HD CP
	H679X	H30	BYSTRONIC NOZZLE - 3.0 mm HD CP

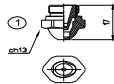

POZ.	NR AWM	NR BYSTRONIC	OPIS
1	H1250	N10-15	BYSTRONIC DOUBLE NOZZLE - 1.0 mm
	H1251	N12-15	BYSTRONIC DOUBLE NOZZLE - 1.25 mm
	H1252	N15-15	BYSTRONIC DOUBLE NOZZLE - 1.5 mm
	H1253	N17-15	BYSTRONIC DOUBLE NOZZLE - 1.75 mm
	H1254	N20-15	BYSTRONIC DOUBLE NOZZLE - 2.0 mm
	H1255	N25-15	BYSTRONIC DOUBLE NOZZLE - 2.5 mm
	H1256	N25-20	BYSTRONIC DOUBLE NOZZLE - 2.5 mm
	H1257	N30-17	BYSTRONIC DOUBLE NOZZLE - 3.0mm
	H1258	N30-20	BYSTRONIC DOUBLE NOZZLE - 3.0 mm
	H1250X	N10-15	BYSTRONIC DOUBLE NOZZLE - 1.0 mm CP
	H1251X	N12-15	BYSTRONIC DOUBLE NOZZLE - 1.25 mm CP
	H1252X	N15-15	BYSTRONIC DOUBLE NOZZLE - 1.5 mm CP
	H1253X	N17-15	BYSTRONIC DOUBLE NOZZLE - 1.75 mm CP
	H1254X	N20-15	BYSTRONIC DOUBLE NOZZLE - 2.0 mm CP
	H1255X	N25-15	BYSTRONIC DOUBLE NOZZLE - 2.5 mm CP
	H1256X	N25-20	BYSTRONIC DOUBLE NOZZLE - 2.5 mm CP
	H1257X	N30-17	BYSTRONIC DOUBLE NOZZLE - 3.0 mm CP
	H1258X	N30-20	BYSTRONIC DOUBLE NOZZLE - 3.0 mm CP

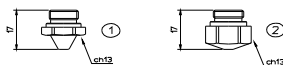

POZ.	NR AWM	NR BYSTRONIC	OPIS	
1	H22	3-04271 08	BYSTRONIC NOZZLE - 0.8 mm	
	H14	3-01894 10	BYSTRONIC NOZZLE - 1.0 mm	
	H41	3-01895 12	BYSTRONIC NOZZLE - 1.25 mm	
	H17	3-01896 15	BYSTRONIC NOZZLE - 1.5 mm	
	H42	3-01897 17	BYSTRONIC NOZZLE - 1.75 mm	
	H33	3-01898 20	BYSTRONIC NOZZLE - 2.0 mm	
	H43	3-01899 H10	BYSTRONIC NOZZLE - 1.0 mm HD	
	H16	3-01900 H12	BYSTRONIC NOZZLE - 1.25 mm HD	
	H44	3-01901 H15	BYSTRONIC NOZZLE - 1.5 mm HD	
	H45	3-01902 H17	BYSTRONIC NOZZLE - 1.75 mm HD	
	H46	3-01903 H20	BYSTRONIC NOZZLE - 2.0 mm HD	
	2	H71	3-04273 K08	BYSTRONIC NOZZLE - 0.8 mm
		H107	3-01905 K10	BYSTRONIC NOZZLE - 1.0 mm
		H108	3-01906 K12	BYSTRONIC NOZZLE - 1.25 mm
H109		3-01907 K15	BYSTRONIC NOZZLE - 1.5 mm	
H110		3-01908 K17	BYSTRONIC NOZZLE - 1.75 mm	
H111		3-01909 K20	BYSTRONIC NOZZLE - 2.0 mm	
H89		3-01910 HK10	BYSTRONIC NOZZLE - 1.0 mm HD	
H112		3-01911 HK12	BYSTRONIC NOZZLE - 1.25 mm HD	
H113		3-01912 HK15	BYSTRONIC NOZZLE - 1.5 mm HD	
H114		3-01913 HK17	BYSTRONIC NOZZLE - 1.75 mm HD	
H115		3-01914 HK20	BYSTRONIC NOZZLE - 2.0 mm HD	

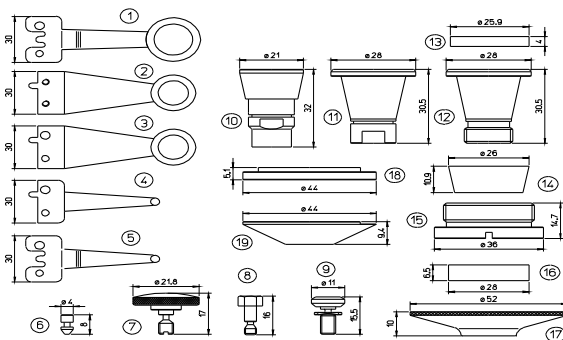

POZ.	NR AWM	NR BYSTRONIC	OPIS
1	HA26	3-05530	BYSTRONIC SCANNER
2	HA5	2-01262	BYSTRONIC SCANNER
3	HA252	2-02015	BYSTRONIC SCANNER
4	HA251	2-02016	BYSTRONIC BALL SCANNER
5	HA273		BYSTRONIC BALL SCANNER
6	HA24	4-03137	BYSTRONIC PIN
7	HA25	4-03136	BYSTRONIC KNURLED SCREW - BRASS
8	HA1	4-00324	BYSTRONIC KNURLED SCREW
9	HA208	3-09001	BYSTRONIC SCREW FOR CROSS-JET
10	HA188	3-02291	BYSTRONIC NOZZLE BODY
11	HA102	3-05497	BYSTRONIC COPPER NOZZLE BODY
12	HA172	2-08701	BYSTRONIC NOZZLE BODY
13	HA125	4-01642	BYSTRONIC CERAMIC INSULATING DISC
	HA231	4-01642	BYSTRONIC CERAMIC INSULATING DISC NEW VERSION
14	HA124	4-01959	BYSTRONIC CERAMIC CONE
	HA230	4-01959	BYSTRONIC CERAMIC CONE - NEW VERSION
15	HA174	3-11071	BYSTRONIC FASTENING NUT
16	HA126	4-09010	BYSTRONIC CERAMIC INSULATING RING
17	HA173	2-08700	BYSTRONIC SIGNBOARD
	HA173X		BYSTRONIC SIGNBOARD CP
17	HA206	3-03663-T	BYSTRONIC TEFLON DISC
18	HA205	3-03663-C	BYSTRONIC SIGNBOARD
19	HA246		BYSTRONIC SCREW KIT (3 PCS) FOR AL205

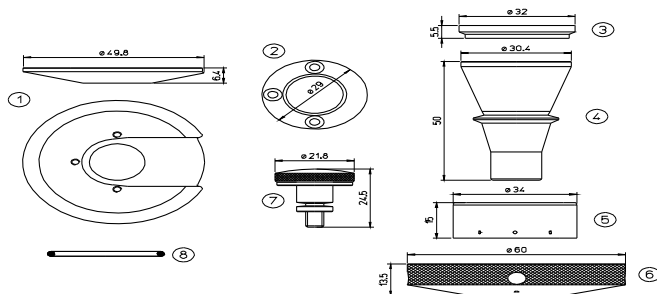

POZ.	NR AWM	NR BYSTRONIC	OPIS
1	HA222	3-06035	BYSTRONIC SIGNBOARD COPPER ONLY
	HA245		BYSTRONIC SCREW KIT (3 PCS) FOR AL222
2	HA120	3-06035-T	BYSTRONIC DISC TEFLON
	HA120/P	3-06035-P	BYSTRONIC DISK LONG LIFE
3	HA215	3-13113	BYSTRONIC INSULATING RING
4	HA214	2-10837	BYSTRONIC NOZZLE BODY
5	HA216	3-13422	BYSTRONIC INSULATING RING WITH HOLES
6	HA258	3-13110	BYSTRONIC SHIELD COPPER
7	HA209	4-04976	BYSTRONIC KNURLED SCREW
8	HA225	3141300	BYSTRONIC O-RING
	HA226	3141122	BYSTRONIC O-RING
	3140236	3140236	BYSTRONIC O-RING
	HA99	3140820	BYSTRONIC O-RING FOR LENS

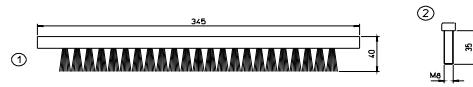

POZ.	NR KAT.	NR PROD.	OPIS
1	HA300	2-06511	BYSTRONIC BRUSH 345x30x20 WITH SCREWS
2	B33884	B33884	BYSTRONIC PLASTIC SCREWS DIN 912 8X35 - 2 pcs

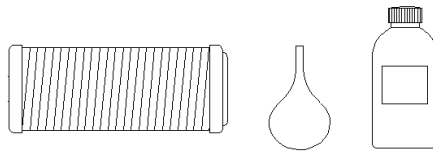

POZ.	NR AWM	NR BYSTRONIC	OPIS
1	7004621	0020	BYSTRONIC AIR FILTER DELTEC
2	7001341	71064753	BYSTRONIC VACUUM PUMP FILTER
3	8820145	8820145	BYSTRONIC WATER FILTER 60M/C
4	8820154	8820154	BYSTRONIC WATER FILTER 140M/C
5	7509417	A37100MFO	BYSTRONIC GREEN AIR FILTER 37X106
6	7509412		BYSTRONIC AIR FILTER ACTIVE COAL
7	SV16/25		BYSTRONIC FILTR DO POMPY PRÓŻNIOWEJ
8			BYSTRONIC OLEJ DO POMPY PRÓŻNIOWEJ - 1 L
9	870000084		BYSTRONIC DERLIKON LEYBOLD VACUUM - 300 ml
10	ZYWICA		ZYWICA DEJONIZACYJNA - 5 kg
11	M 1520 755		MATA FILTRACYJNA 1520 x 755 mm (190g/m2) G3
12	M 1670 660		MATA FILTRACYJNA 1670 x 660 mm (190g/m2) G3
13	M 2420 560		MATA FILTRACYJNA 2420 x 560 mm (190g/m2) G3
14	M 1200 700		MATA FILTRACYJNA 1200 x 700 mm (190g/m2) G3
15	M 990 890		MATA FILTRACYJNA 990 x 890 mm (190g/m2) G3
16	M 1200 600		MATA FILTRACYJNA 1200 x 600 mm (190g/m2) G3



POZ.	NR AWM	NR BYSTRONIC	OPIS
1	MLECZKO 250		MLECZKO DO POLEROWANIA OPTYKI - 250 ml
2	MLECZKO 50		MLECZKO DO POLEROWANIA OPTYKI - 50 ml
3	PAPIERKI 500		PAPIERKI CZYSZCZĄCE 10x20 cm - 500 szt.
4	PAPIERKI 50		PAPIERKI CZYSZCZĄCE 10x15 cm - 50 szt.
5	WACIKI 100		WACIKI CZYSZCZĄCE - 100 szt.
6	PATYCZKI 20		PATYCZKI BAWELNIANE - 20 szt.
7	ACETON		ACETON - 250 ml
	HA1015		OKULARY DO LASERA WZMOCNIONE
8	HA2012		OKULARY DO LASERA UMOŻLIWIAJĄCE MONTAŻ WKŁADU KOREKCYJNEGO
	HA3018		OKULARY DO LASERA WENTYLOWANE OKULARY KOSZYKOWE

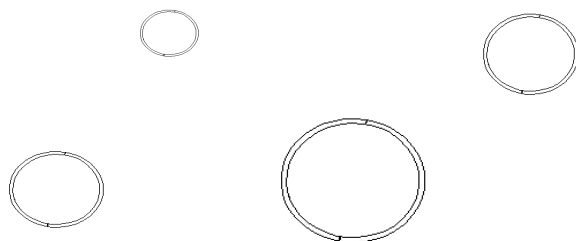

POZ.	NR AWM	NR BYSTRONIC	OPIS
1			DIAM: 38,1 (1,5") mm, FL: 127,0 (5,0") mm ET: 6,0 mm WKLESŁO-WYPUKŁA
2			DIAM: 38,1 (1,5") mm, FL: 190,5 (7,5") mm ET: 6,0 mm WKLESŁO-WYPUKŁA
3			DIAM: 38,1 (1,5") mm, FL: 127,0 (5,0") mm ET: 9,0 mm WKLESŁO-WYPUKŁA
4			DIAM: 38,1 (1,5") mm, FL: 190,5 (7,5") mm ET: 9,0 mm WKLESŁO-WYPUKŁA
5			DIAM: 38,1 (1,5") mm, FL: 127,0 (5,0") mm ET: 9,0 mm WKLESŁO-WYPUKŁA
6			DIAM: 38,1 (1,5") mm, FL: 190,5 (7,5") mm ET: 9,0 mm WKLESŁO-WYPUKŁA